

MANUAL

PALLEMØBEL
KATRINE HEDEGAARD NIELSEN
KRABBESHOLM HØJSKOLE 2009



MANUAL TIL PALLEMØBEL

KATRINE HEDEGAARD NIELSEN, KRABBESHOLM '09

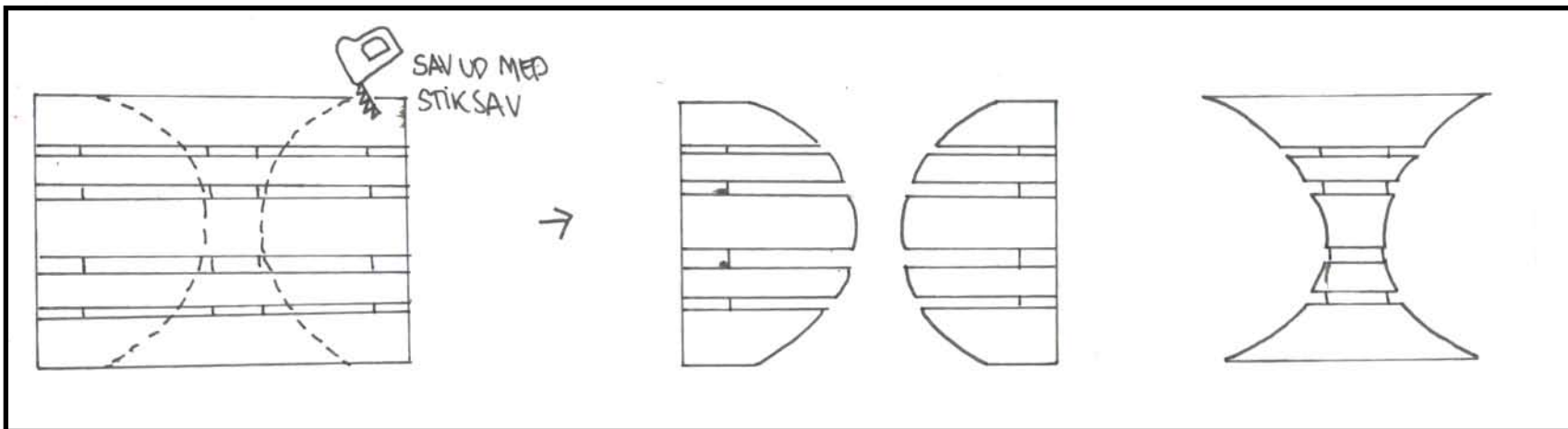
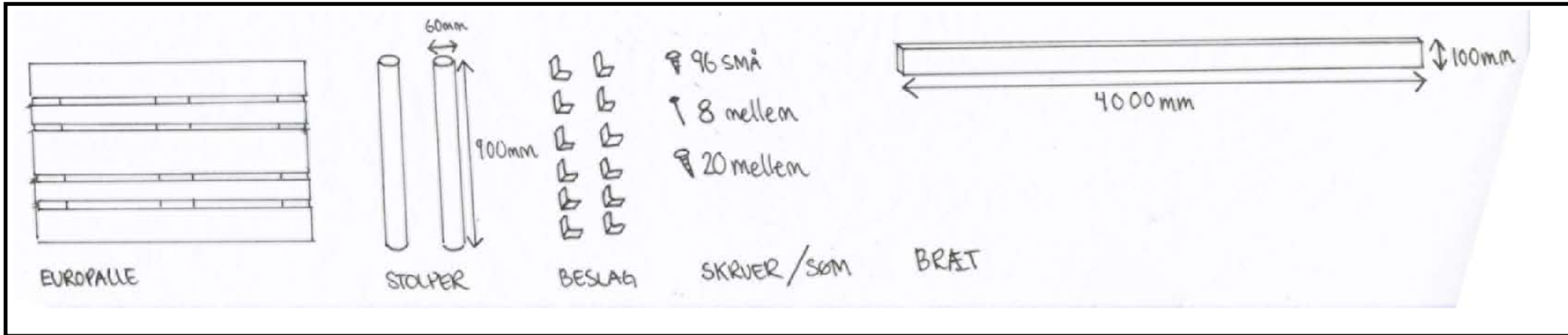

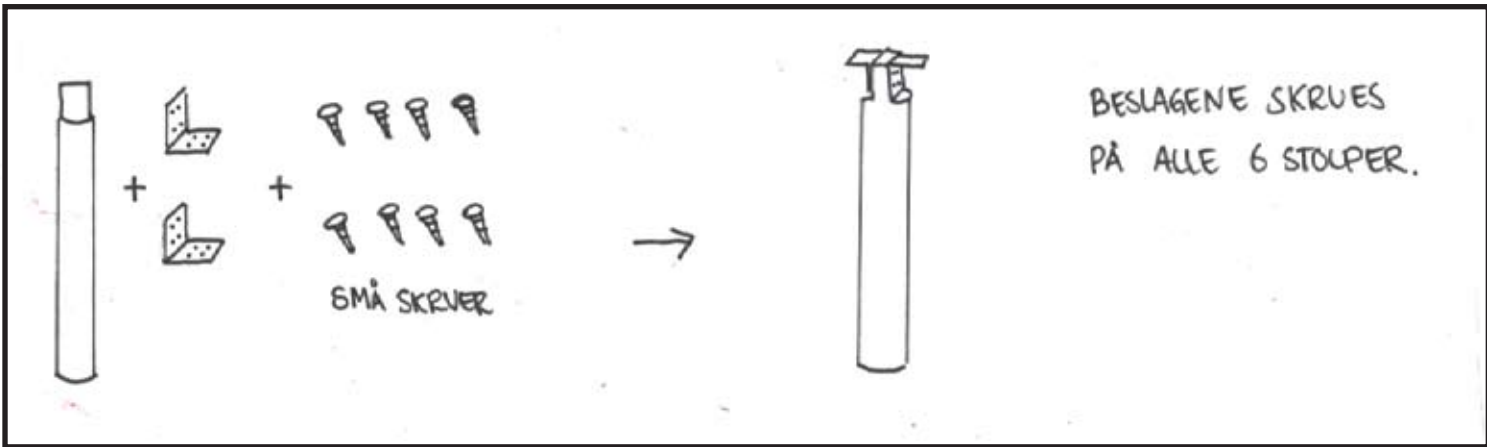
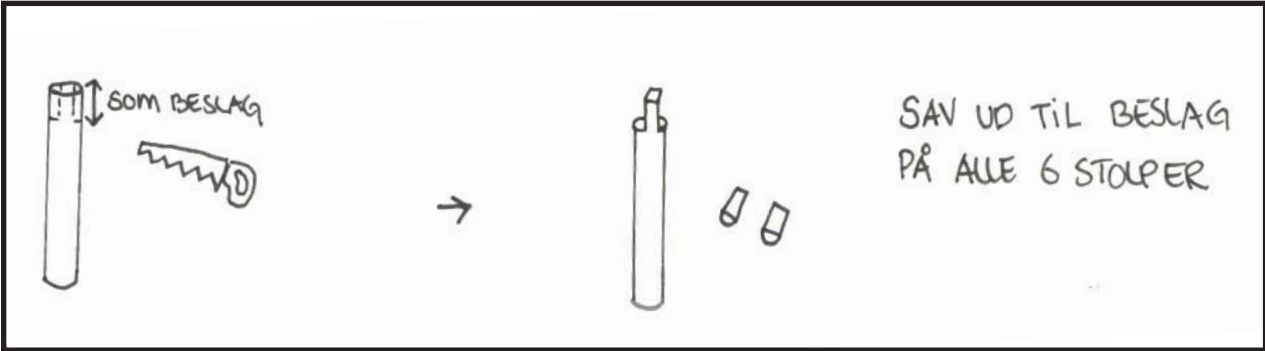
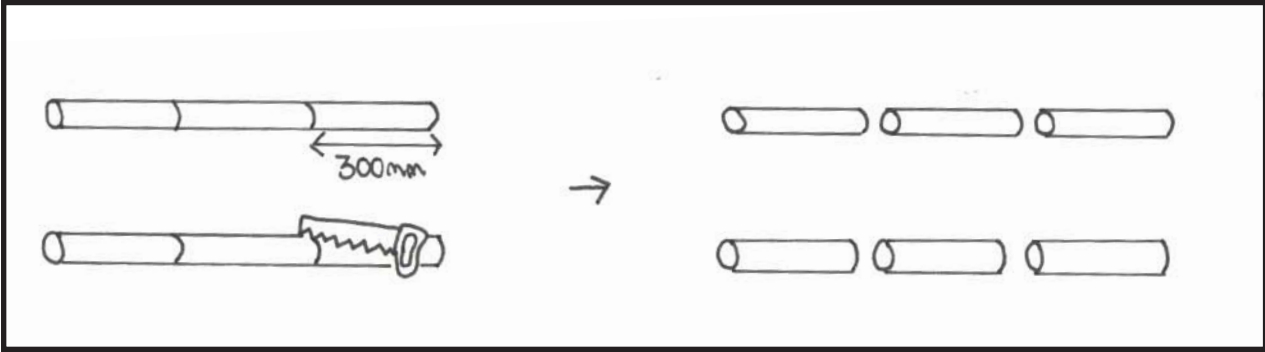

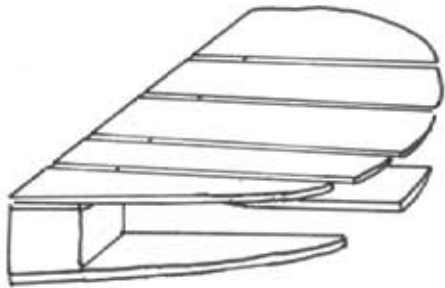

MONTER STØTTEBRÆT PÅ BEGGE HALVCIRKLER.

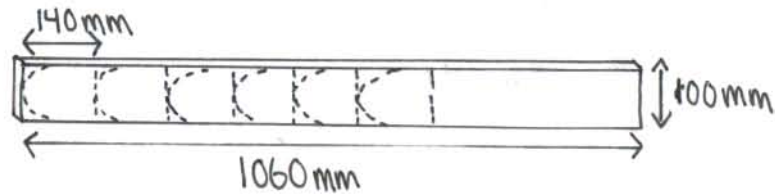
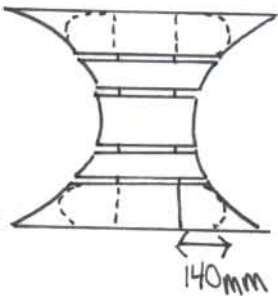
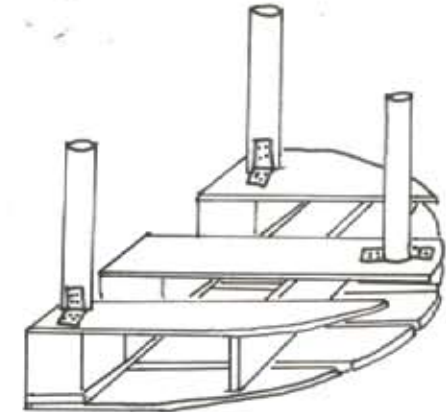
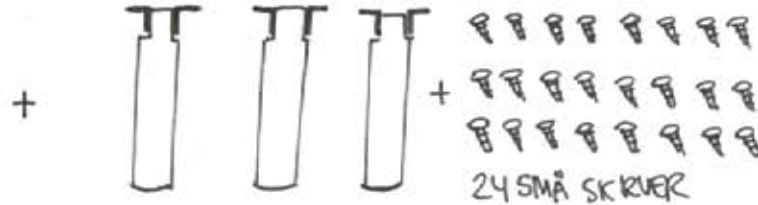
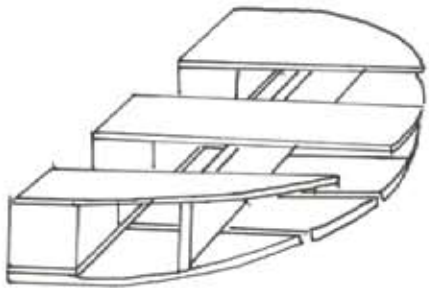
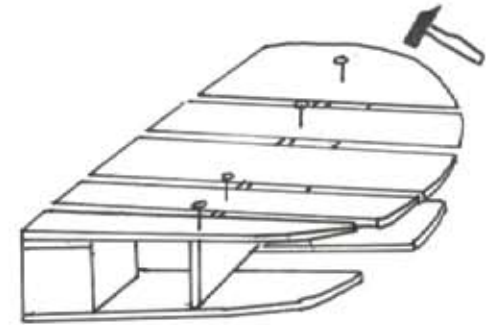
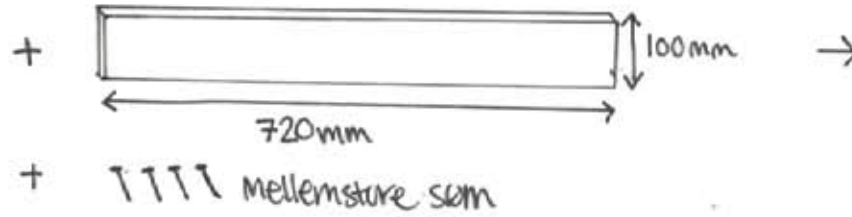

 SAV BUERNE UD MED STIKSAVEN.

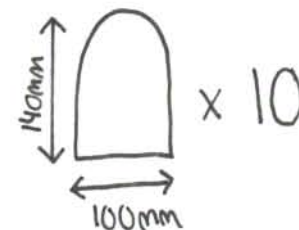

BUERNE SLIBES & MALES

